

## OWNER'S MANUAL

THANK YOU VERY MUCH FOR PURCHASING THIS BMB SPEAKERS SYSTEM. BEFORE USE, PLEASE READ FOLLOWING INSTRUCTIONS THROUGH CAREFULLY AND FAMILIARIZE YOURSELF WITH THE OPERATION OF THE SYSTEM.

### BEFORE USE

#### Operating Precautions

- The maximum input power of these speakers is 700 W (at peak). Higher levels of input power may cause damage to the speaker system and so take every precaution to keep the power down to the specification.
- Even if an amplifier with a maximum output power of less than 700 W is employed, do not use the speakers with the volume turned up too high or the sound distorted. This may damage the speakers.
- Make sure that the amplifier's power switch is at the OFF position when connecting the speakers to the amplifier.
- Make sure that the amplifier's volume control is turned down to its lowest setting when the amplifier's power switch is set to the ON position.

### CONNECTIONS

- Make sure that you set the power switch on the amplifier to the OFF position when connecting the speakers to the amplifier.
- Align the (-) and (+) polarities of the speakers with the (-) and (+) polarities of the left (L) and right (R) channels of amplifier, and connect the speakers to the speaker terminals on the amplifier. (Please refer to the below drawing.)

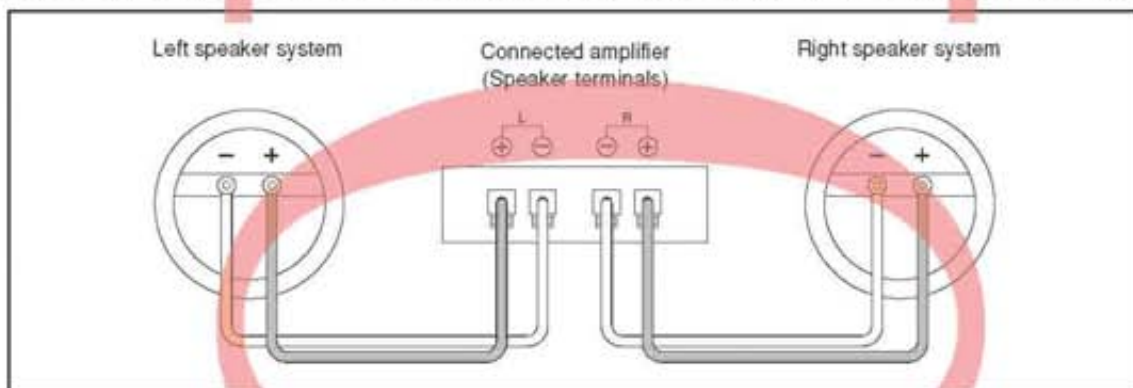

- \* If the polarities of the left and right speakers are not aligned properly, the quality of the reproduced sound, the ambience and the feeling of direction will all be markedly impaired.
- \* When making the connections, take every precaution to prevent the speaker cords' central cores from being shorted.

### INSTALLATION

#### Installing the Speakers

- Avoid installing the speakers in a location exposed to direct sunlight and high levels of humidity. Avoid also locations in the vicinity of stoves and other sources of heat.
- With a speaker system, the sound which is heard varies greatly according to the installation location. Bear in mind the following points in order to derive the most enjoyment from music.
  - a) Install the speaker at the upper position than your ears level when you listen to the sound under normal listening conditions.
  - b) The best distance between the speakers is approx. 2 to 5 m.
  - c) The bass sounds fuller if the speakers are installed on a solid and stable stand or shelf, or if they are placed against a wall. The bass sound will lose its impact if objects which do not reflect the bass well enough are placed in front of the speakers.
- If you plan to hang your speakers from the ceiling, contact a professional installer.

#### **Caution:**

If you want to suspend the CSX-1000 from the ceiling, use adequate mounting hardware that can bear the load. In addition, be sure to secure the mounting hardware onto a place of high-tensile strength using screws appropriate to the ceiling materials.

## MAINTENANCE OF CABINET

When the cabinets are dirty, clean off the dirt with a soft cloth. If the dirt is engrained, moisten a soft cloth in cold or lukewarm water, wring it out, and then wipe off the dirt. **Never use thinners or alcohol** since these substances can impair the finish of the cabinet. Also, avoid using insecticide and other sprays near the speakers.

## SPECIFICATIONS

Type: BASS-REFLEX SYSTEM  
 Speaker units: 30 cm WOOFER x 1  
 8 cm TWEETER x 2  
 8 cm SQUAWKER x 2  
 High-performance oven cone  
 Maximum input power: 700 W  
 Sound pressure level: 90 dB/W/m  
 Frequency response: 40 - 20 kHz  
 Impedance: 8 Ω  
 Dimensions: 568 (W) x 350 (H) x 336 (D)  
 Mass: 18.5 kg

### STRAIGHT AHEAD FROM THE TWEETER

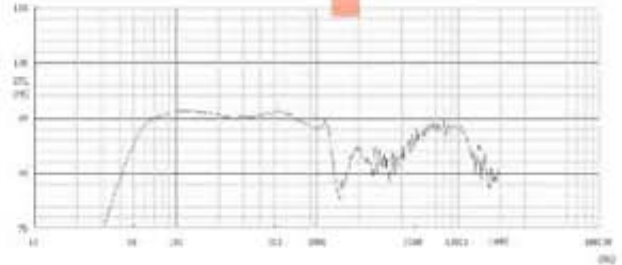

### IMPEDANCE

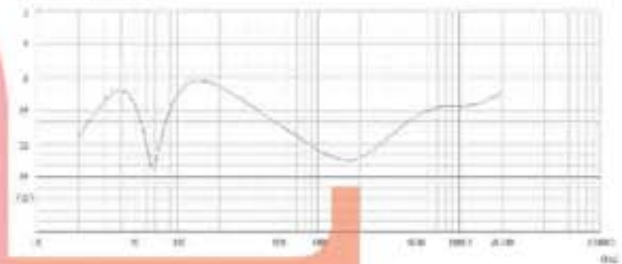

## ACCESSORIES

Owner's manual: 1 pc

## Making Allowable Connections between Speakers and Your Amplifier (Ex. 4 Speakers)

■ Configure and wire the speakers so that the combined impedance falls within 6 to 32 Ω.

**Note:**

The specification allows the combined impedance ranging 4 to 32 Ω, however, 4 Ω configuration is not recommended; avoid it whenever possible.

### Allowable Examples

#### Allowable Example 1

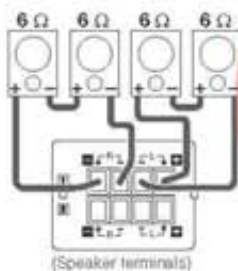

OK: Combined impedance is 12 Ω

#### Allowable Example 2

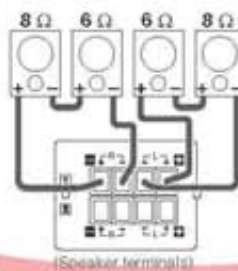

OK: Combined impedance is 14 Ω

#### Allowable Example 3

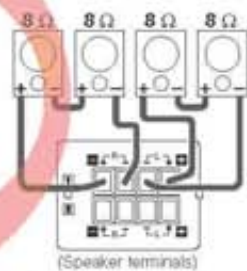

OK: Combined impedance is 16 Ω

### Not-allowable Examples

#### Not-allowable Example 1

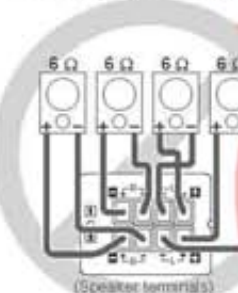

NG: Combined impedance is 3 Ω

#### Not-allowable Example 2

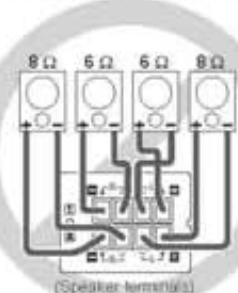

NG: Combined impedance is 3.4 Ω

#### Not-allowable Example 3

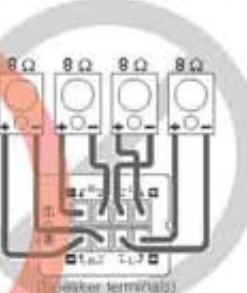

NG: Combined impedance is 4 Ω

## About Multidirectional Method Speakers

The CSX-1000 features a multi-speaker configuration based on the multidirectional method that is capable of delivering a dynamic sound widely even in a spacious room. It comprises five speakers: a woofer located in the center of the cabinet responsible for deep bass, a pair of squawkers reproducing mid/high frequencies, and a pair of tweeters for high tones. The pairs of squawkers and tweeters are installed in the cabinet with specific angles. In addition, the squawker units situated in the middle of the box can be vectored to any direction to support various environment conditions. They are set by factory default to the standard position so as to create a sound field all over the floor level in a big room. However, you may want to change the direction of the squawker units in the following situations:

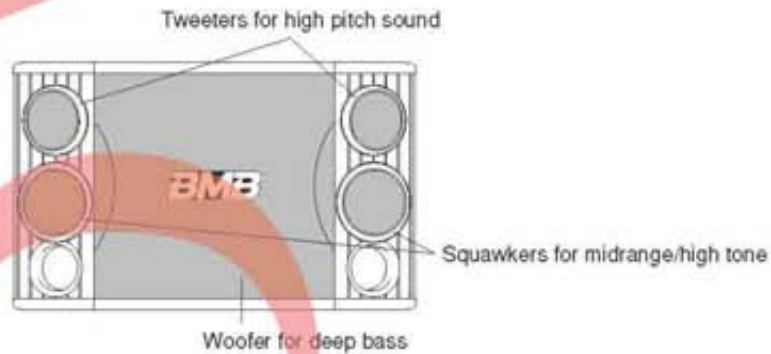

### ■ If you want to expand the sound field all over a big room, in stead of focusing on the floor level...

1. Pull the right and left speaker grills firmly to remove them. (Each speaker grill has a set of safety catches on the upper and lower ends, which are locked to the cabinet. You can easily release the lock to remove the grill by pulling hard the duct hole with a hand.)

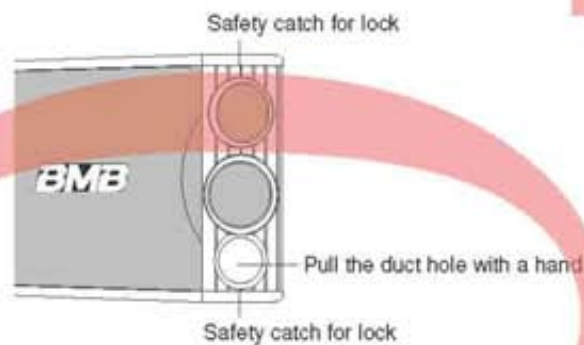

2. Use a Phillips-head screwdriver to remove the four screws that hold the squawker to the cabinet.

#### Caution:

Do not unscrew the four screws that hold the squawker to its black platform. In addition, make sure never to remove the tweeters located above the squawker; the tweeters are identical in appearance to the squawker units. Note that you can not change the direction of the tweeters.

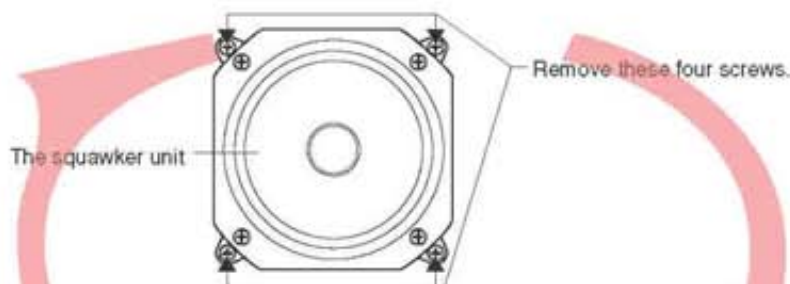

3. Rotate the squawker with its black platform 180 degrees clockwise or counterclockwise so that it points significantly outward, and then secure it with the four screws. Make sure to secure at the same time a thin airtight gasket between the platform and the cabinet.

**Caution:**

Once you removed the screws, avoid pulling out, dropping or rotating more than 180 degrees the squawker unit, or the cable may be disconnected from the unit.

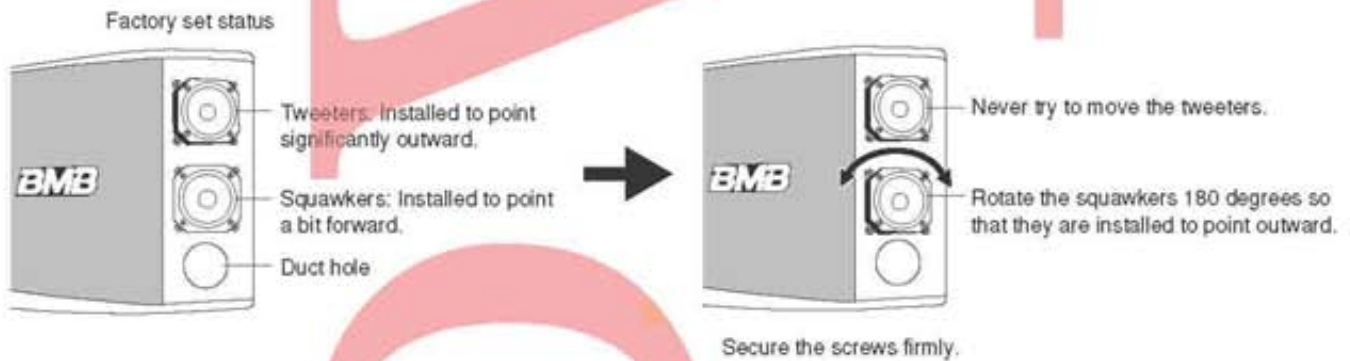

4. Push the grills in place, pressing with a finger the safety lock catch located in the upper and lower ends of the grill in order that it may not damage the cabinet.

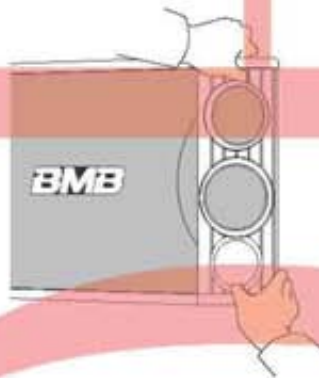

■ When the CSX-1000 create a sound field in a higher area than expected in a high-ceilinged room...

In stead of 180 degrees of rotation applied in step 3 mentioned above, rotate to fix the right and left squawkers 90 degrees counterclockwise so that they point downward.

■ If you want to direct the sound field to a higher position than the speakers level (e.g. terrace theater)

In stead of 180 degrees of rotation applied in step 3 mentioned above, rotate to fix the right and left squawkers 90 degrees clockwise so that they point upward.

